

OLYMPUS ORIGINAL KIT
Quilter's Collection
 Designed by Reiko Kato
 PA-441 SUNBONNET SUE BAG
 Instruction

◆Check the material included and read the instruction before making.
 Finished size : 21cm x 33cm x 8cm (Main bag)
 This kit includes : Olympus fabric (Yarn-dyed and solid), Embroidery threads, Instruction, Full size pattern sheet
 Things required : Quilt batting (40cm x 80cm), Sewing needle, Marking pins, Embroidery needle, Sewing threads, Basting threads, Wasted fabric, Marking pins, Ruler, Scissor, Cardboard, Iron

●OLYMPUS THREAD MFG. CO., LTD●
 ADD: 4-92 Chikara machi, Higashiku Nagoya, Japan
 www.olympus-thread.com

1. Refer to the below layout, cut the fabrics and batting.

- Cut out all paper templates and arrange them on the fabrics and batting before cutting.
- Mark as designated in the templates on the wrong side of the fabrics.

Layout

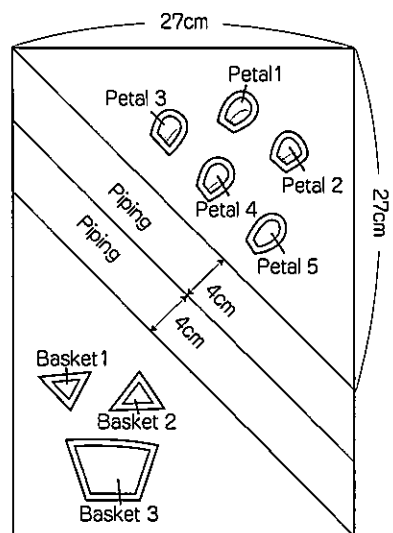

■Yarn-dyed fabric (Check pattern: Beige)

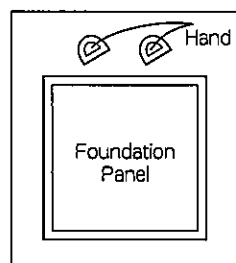

■Yarn-dyed fabric (shaded: White brown)

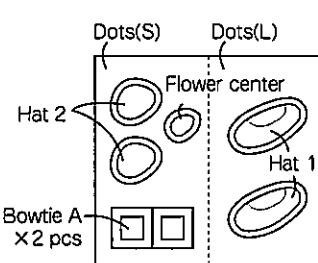

■Yarn-dyed fabric (Dot pattern: Red)

■Yarn-dyed fabric Wave pattern
 Do not iron on the fabric surface. It may disturb its quality. Set the temperature low and put wasted fabric between them.
 Cotton 95%
 Acrylic 2.5%
 Nylon 2.5%

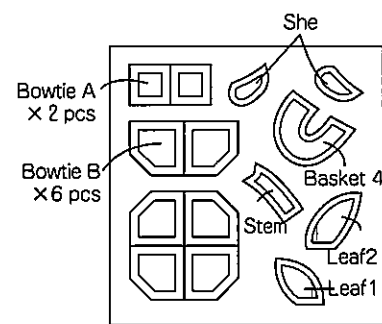

■Yarn-dyed fabric (+ pattern: Green)

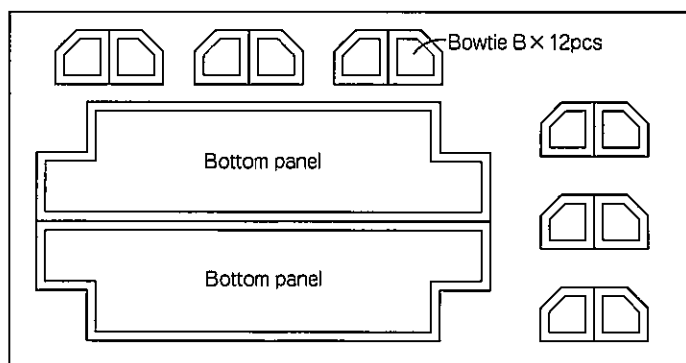

■Yarn-dyed fabric (Shaded: Gray)

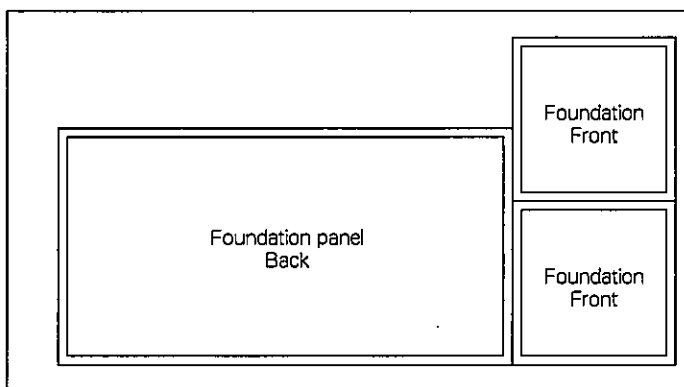

■Yarn-dyed fabric (Wave: Ivory)

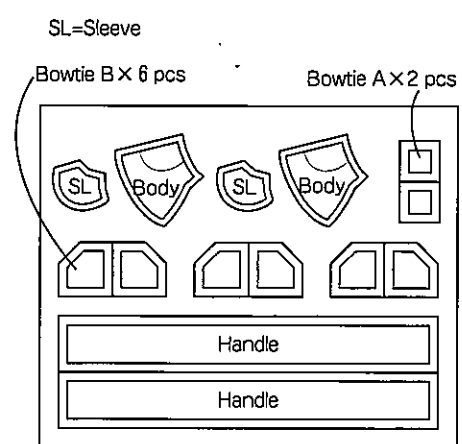

■Yarn-dyed fabric (✦ pattern: Pink)

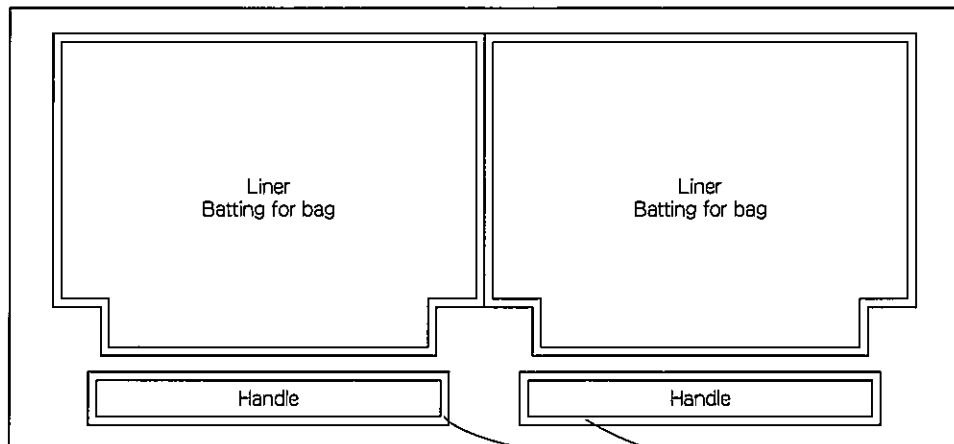

■Solid fabric (Beige)
 ■Quilt batting ※Prepare batting (Approx.40 x 80cm). ※no seam allowance for batting

Tips

- Use marking pins to avoid fabric to be scooped.
- Use the similar colored threads to the fabric.
- ✂Do not notch too deep.
- Use backstitch at the beginning and the end of stitches.
- Check the motif position, referring to the full size pattern sheet.

2. Make a bowtie (Butterfly tie) motif panel.

<Layout>

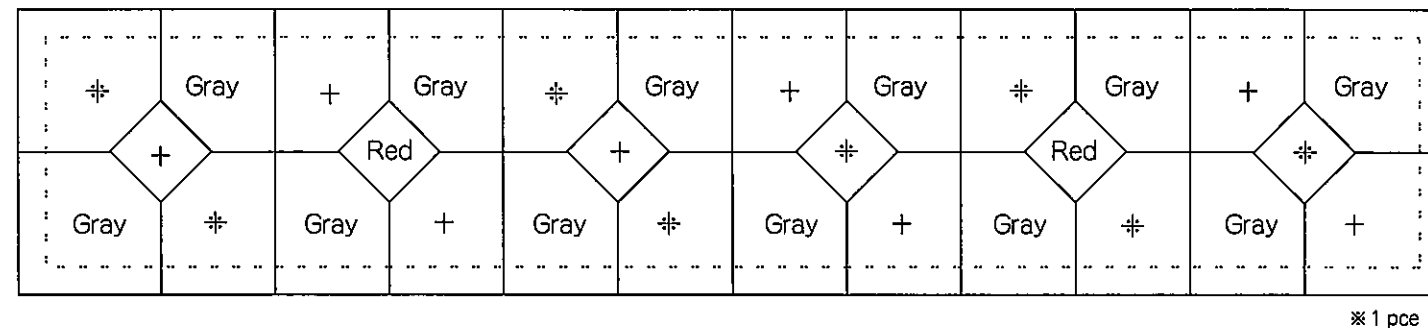

※1 pce

- ① Put the right side of bowtie pieces together and stitch them together as shown below.
 ※Do not stitch the seam.

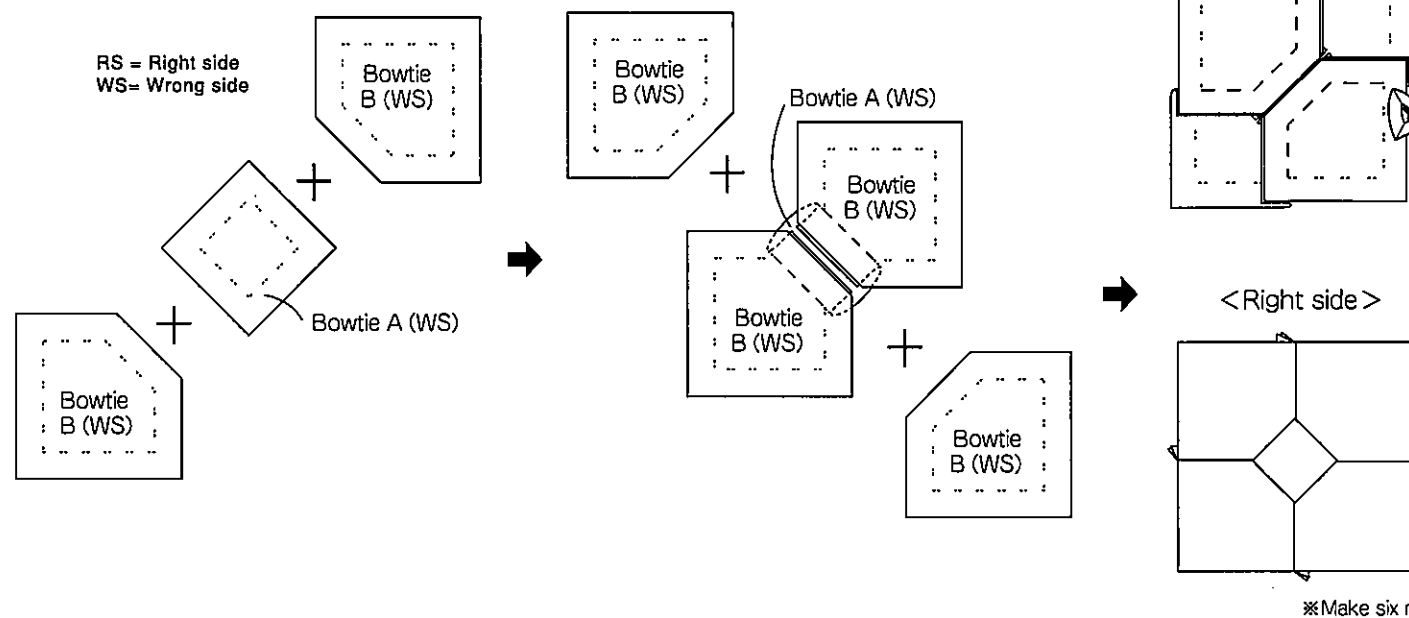

※Make six motifs.

- ② Stitch six pieces of ① together.

<Right side>

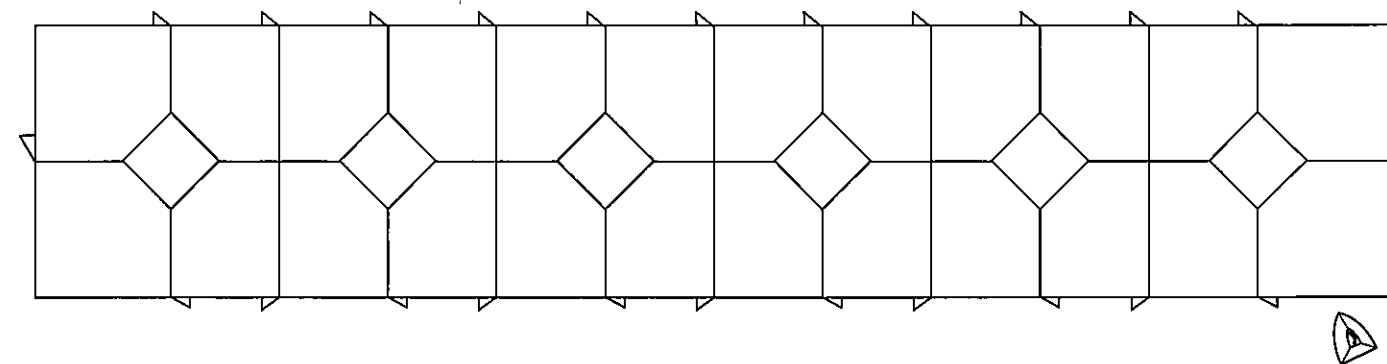

3. Make foundation panels with applique.

① Attach appliques to the foundation panel (front) and stitch using embroidery threads. Stitch them together.

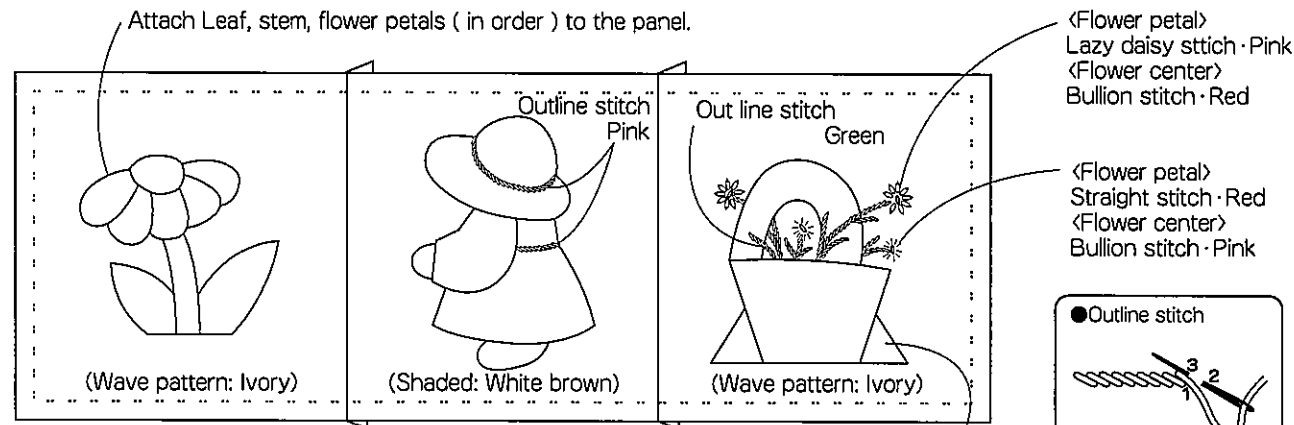

Attach basket pices (1 to 4 in order) to the foundation panel.

② Attach appliques to the foundation panel (Back) and stitch using the embroidery threads.

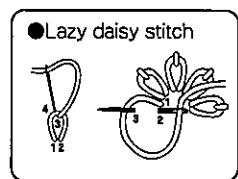
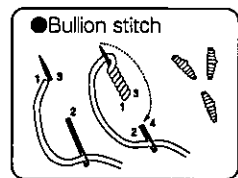
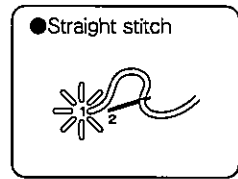
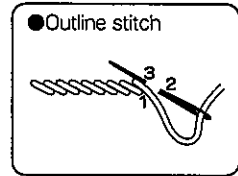
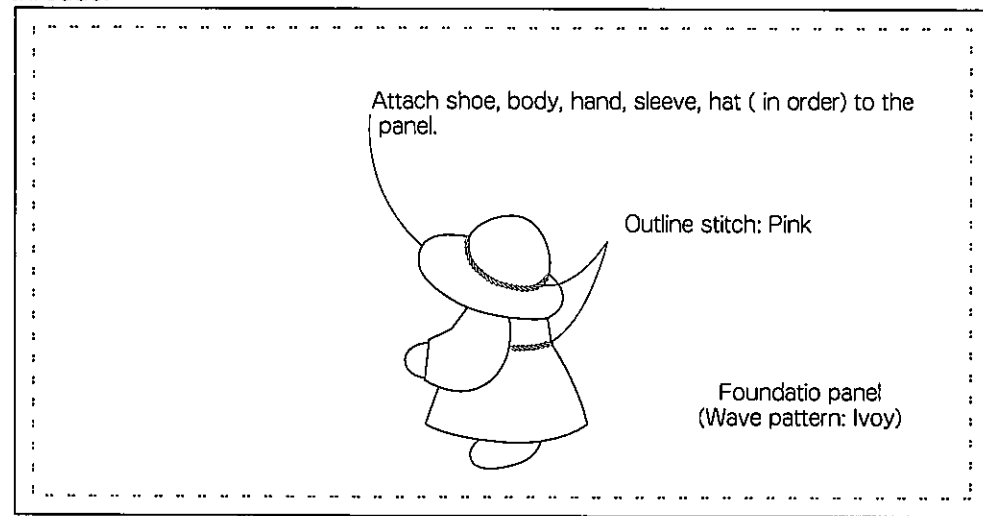

●How to applique

※Glue the template on your cardboard and cut it out.

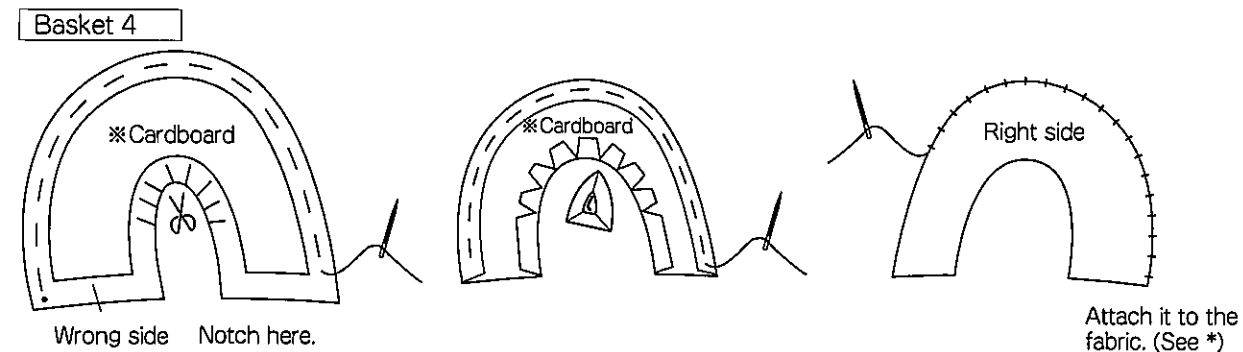
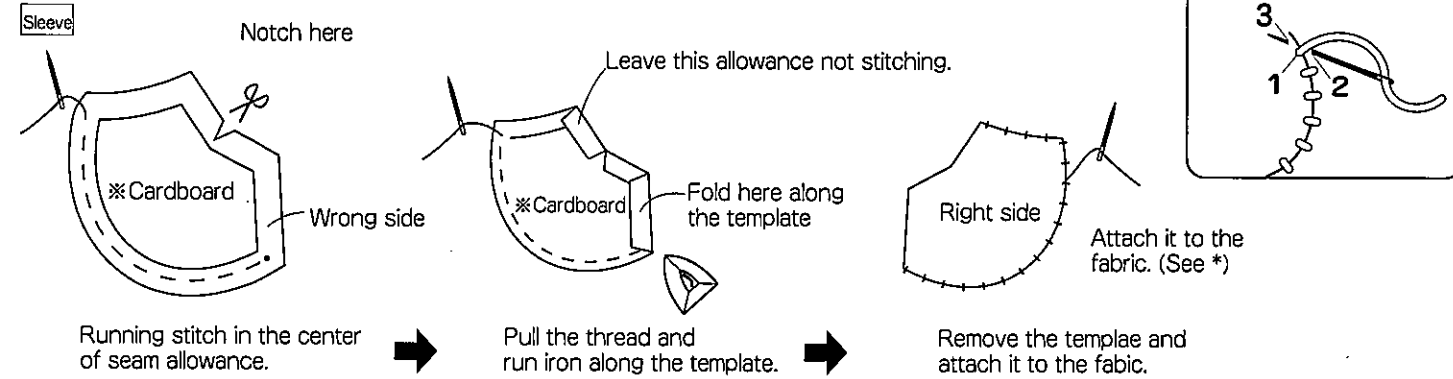

4. Make the main bag panel.

① Put the right side of each part together and stitch them together.

<Main bag panel · Front>

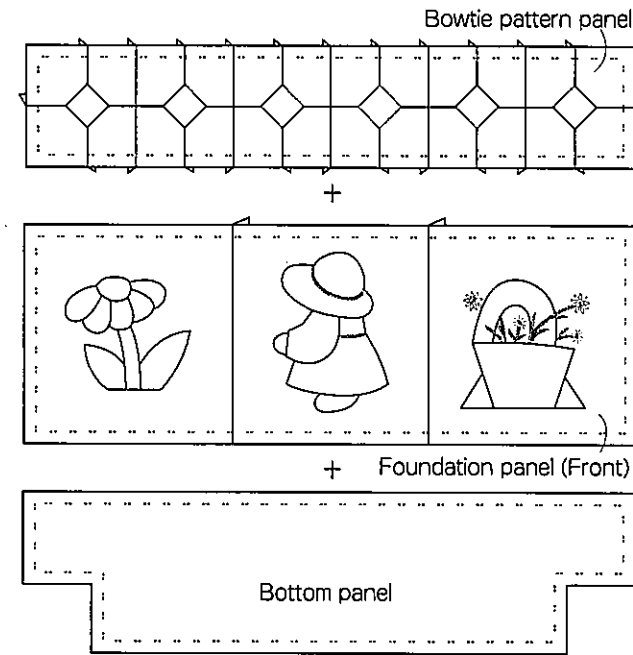

<Main bag panel · Back>

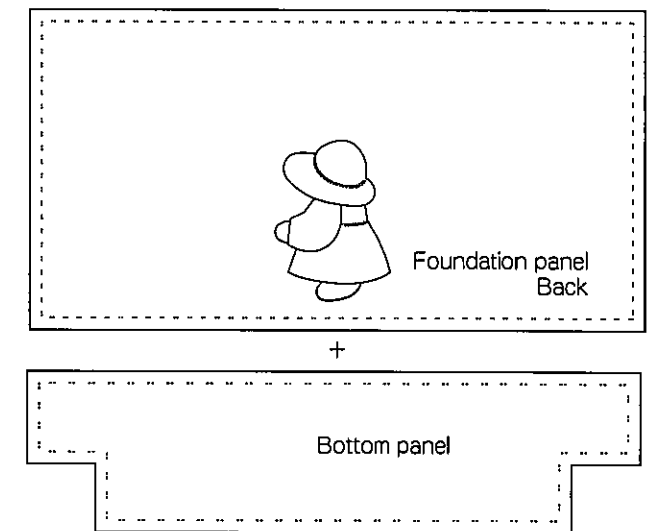

5. Stitch quilting.

① Put the batting on the wrong side of the panel and baste it. Stitch around the motifs.

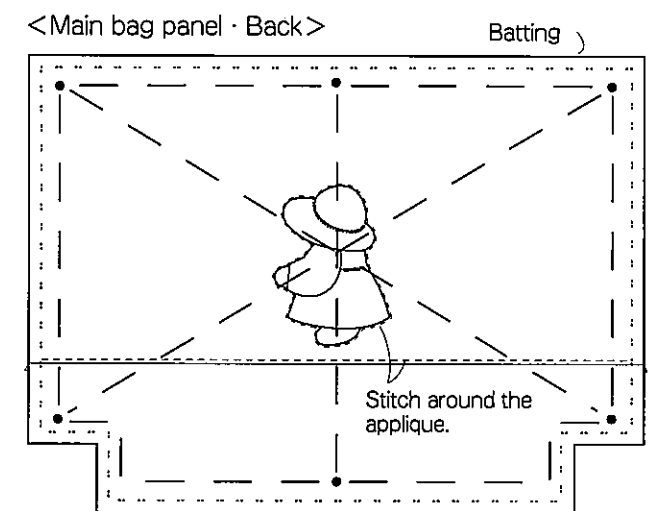
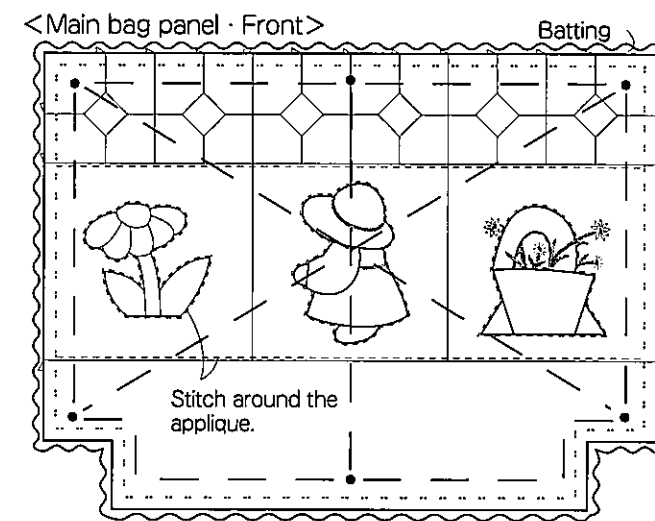

② Stitch quilting.

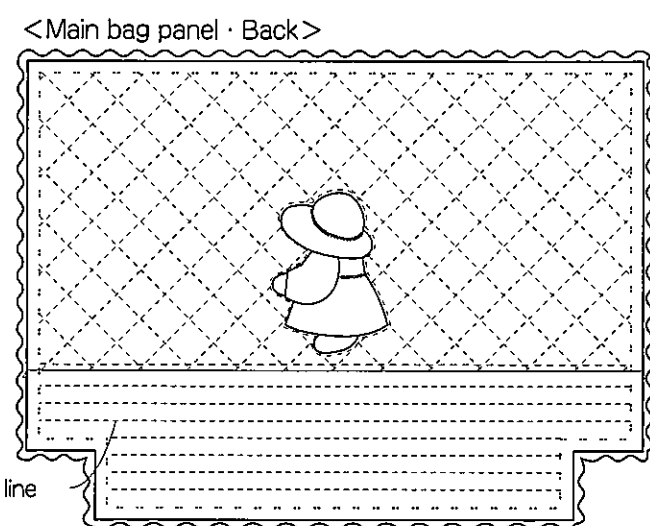
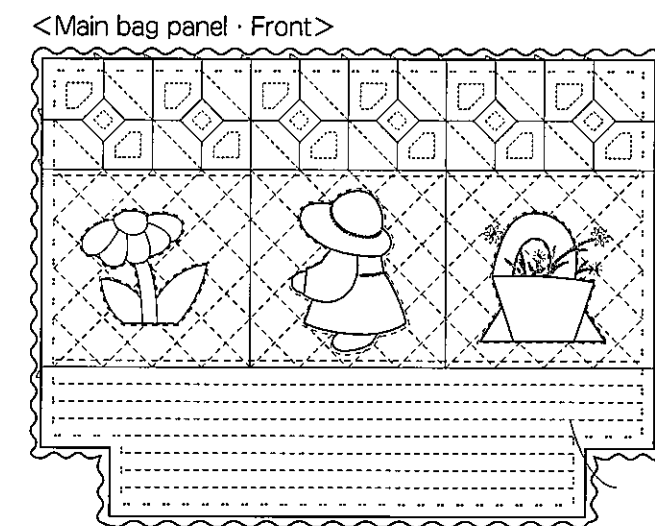

6. Finish it.

① Put the right side of main bag panels (front and back) together and stitch the bottom, side and the gusset (in order) together.

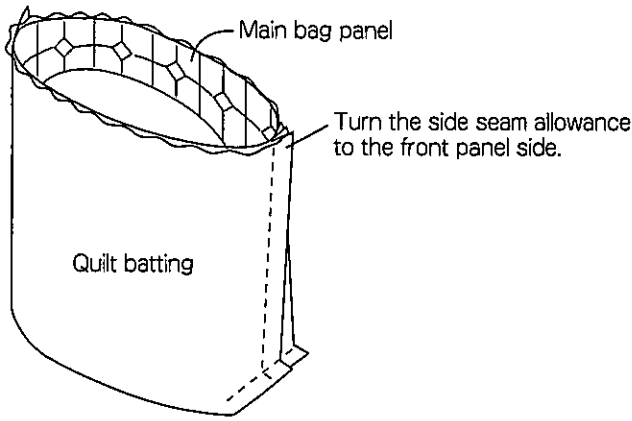

② Stitch the liner bag like the same way as the main bag panel. Put it into the turned main bag panel.

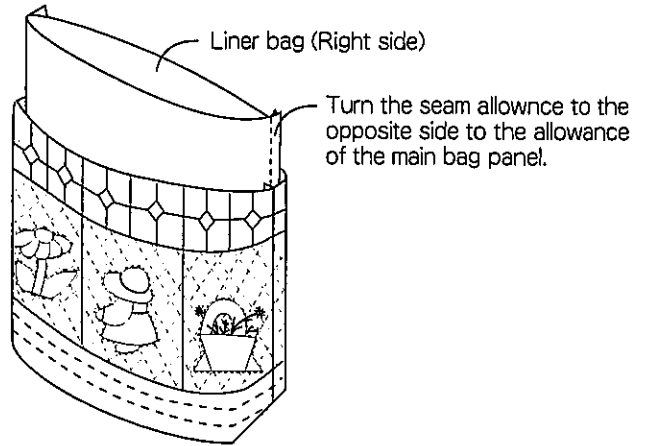

③ Attach the piping to the top.

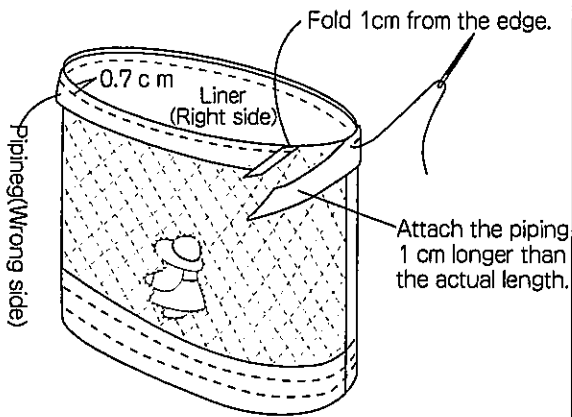

●How to attach a piping tape.

① Stitch two piping tapes together.

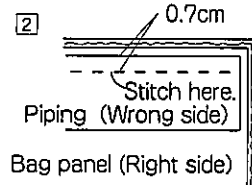
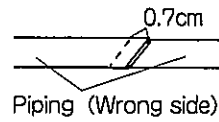

③ Wrap the seam allowance with the piping tape.

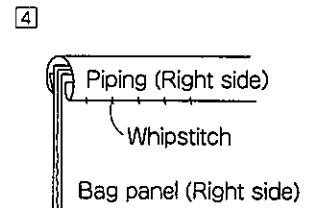
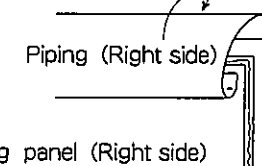

④ Put the right side of handle parts together and stitch one side of them together.

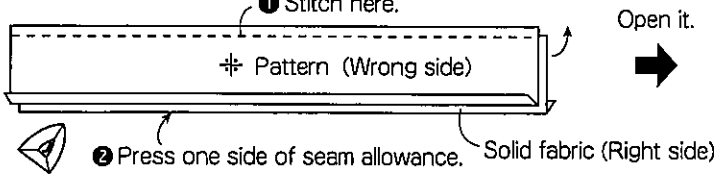

Open it.

③ Put the batting on the wrong side of ✂ fabric.

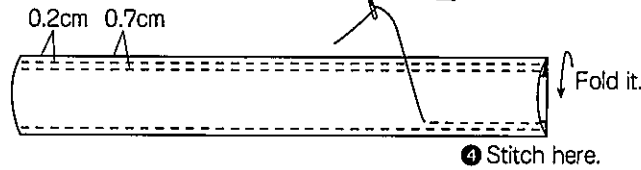
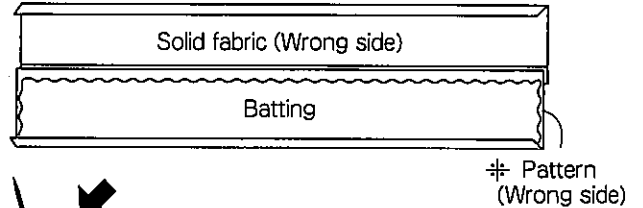

⑤ Attach the handle to the bag.

Put the both sides of the handle and stitch them together.

